

TABLO 1- RADYOİZOTOPLAR İÇİN A₁ ve A₂ SINIR DEĞERLERİ

Radyoizotop (Atom numarası)	A ₁ (TBq)	A ₂ (TBq)	Muaf madde için radyoaktivite konsantrasyonu Bq/g	Muaf taşıma için radyoaktivite sınırı Bq
Actinium (89)-Aktinyum				
Ac-225 (a)	8×10^{-1}	6×10^{-3}	1×10^1	1×10^4
Ac-227 (a)	9×10^{-1}	9×10^{-5}	1×10^{-1}	1×10^3
Ac-228	6×10^{-1}	5×10^{-1}	1×10^1	1×10^6
Silver (47)-Gümüş				
Ag-105	2×10^0	2×10^0	1×10^2	1×10^6
Ag-108m (a)	7×10^{-1}	7×10^{-1}	$1 \times 10^1(b)$	$1 \times 10^6(b)$
Ag-110m (a)	4×10^{-1}	4×10^{-1}	1×10^1	1×10^6
Ag-111	2×10^0	6×10^{-1}	1×10^3	1×10^6
Aluminum (13)-Alüminyum				
Al-26	1×10^{-1}	1×10^{-1}	1×10^1	1×10^5
Americium (95)-Amerisyum				
Am-241	1×10^1	1×10^{-3}	1×10^0	1×10^4
Am-242m (a)	1×10^1	1×10^{-3}	$1 \times 10^0(b)$	$1 \times 10^4(b)$
Am-243 (a)	5×10^0	1×10^{-3}	$1 \times 10^0(b)$	$1 \times 10^3(b)$
Argon (18)-Argon				
Ar-37	4×10^1	4×10^1	1×10^6	1×10^8
Ar-39	4×10^1	2×10^1	1×10^7	1×10^4
Ar-41	3×10^{-1}	3×10^{-1}	1×10^{-2}	1×10^9
Arsenic (33)-Arsenik				
As-72	3×10^{-1}	3×10^{-1}	1×10^1	1×10^5
As-73	4×10^1	4×10^1	1×10^3	1×10^7
As-74	1×10^0	9×10^{-1}	1×10^1	1×10^6
As-76	3×10^{-1}	3×10^{-1}	1×10^{-2}	1×10^5
As-77	2×10^1	7×10^{-1}	1×10^3	1×10^6
Astatine (85)-Astatin				
At-211 (a)	2×10^1	5×10^{-1}	1×10^3	1×10^7
Gold (79)-Altın				
Au-193	7×10^0	2×10^0	1×10^2	1×10^7
Au-194	1×10^0	1×10^0	1×10^1	1×10^6
Au-195	1×10^1	6×10^0	1×10^{-2}	1×10^7
Au-198	1×10^0	6×10^{-1}	1×10^2	1×10^6
Au-199	1×10^1	6×10^{-1}	1×10^{-2}	1×10^6
Barium (56)-Baryum				
Ba-131 (a)	2×10^0	2×10^0	1×10^2	1×10^6
Ba-133	3×10^0	3×10^0	1×10^2	1×10^6
Ba-133m	2×10^1	6×10^{-1}	1×10^2	1×10^6
Ba-140 (a)	5×10^{-1}	3×10^{-1}	$1 \times 10^1(b)$	$1 \times 10^5(b)$
Beryllium (4)-Berilyum				
Be-7	2×10^1	2×10^1	1×10^3	1×10^7
Be-10	4×10^1	6×10^{-1}	1×10^4	1×10^6
Bismuth (83)-Bizmut				
Bi-205	7×10^{-1}	7×10^{-1}	1×10^1	1×10^6
Bi-206	3×10^{-1}	3×10^{-1}	1×10^1	1×10^5
Bi-207	7×10^{-1}	7×10^{-1}	1×10^1	1×10^6

Bi-210	1×10^0	6×10^{-1}	1×10^3	1×10^6
Bi-210m (a)	6×10^{-1}	2×10^{-2}	1×10^1	1×10^5
Bi-212 (a)	7×10^{-1}	6×10^{-1}	1×10^1	1×10^5
Berkelium (97)-Berkelyum				
Bk-247	8×10^0	8×10^{-4}	1×10^0	1×10^4
Bk-249 (a)	4×10^1	3×10^{-1}	1×10^3	1×10^6
Bromine (35)-Brom				
Br-76	4×10^{-1}	4×10^{-1}	1×10^1	1×10^5
Br-77	3×10^0	3×10^0	1×10^2	1×10^6
Br-82	4×10^{-1}	4×10^{-1}	1×10^1	1×10^6
Carbon (6)-Karbon				
C-11	1×10^0	6×10^{-1}	1×10^1	1×10^6
C-14	4×10^1	3×10^0	1×10^4	1×10^7
Calcium (20)-Kalsiyum				
Ca-41	Sınırsız	Sınırsız	1×10^5	1×10^7
Ca-45	4×10^1	1×10^0	1×10^4	1×10^7
Ca-47 (a)	3×10^0	3×10^{-1}	1×10^1	1×10^6
Cadmium (48)-Kadmiyum				
Cd-109	3×10^1	2×10^0	1×10^4	1×10^6
Cd-113m	4×10^1	5×10^{-1}	1×10^3	1×10^6
Cd-115 (a)	3×10^0	4×10^{-1}	1×10^2	1×10^6
Cd-115m	5×10^{-1}	5×10^{-1}	1×10^3	1×10^6
Cerium (58)-Seryum				
Ce-139	7×10^0	2×10^0	1×10^2	1×10^6
Ce-141	2×10^1	6×10^{-1}	1×10^2	1×10^7
Ce-143	9×10^{-1}	6×10^{-1}	1×10^2	1×10^6
Ce-144 (a)	2×10^{-1}	2×10^{-1}	$1 \times 10^2(b)$	$1 \times 10^5(b)$
Californium(98)-Kaliforniyum				
Cf-248	4×10^1	6×10^{-3}	1×10^1	1×10^4
Cf-249	3×10^0	8×10^{-4}	1×10^0	1×10^3
Cf-250	2×10^1	2×10^{-3}	1×10^1	1×10^4
Cf-251	7×10^0	7×10^{-4}	1×10^0	1×10^3
Cf-252	5×10^{-2}	3×10^{-3}	1×10^1	1×10^4
Cf-253 (a)	4×10^1	4×10^{-2}	1×10^2	1×10^5
Cf-254	1×10^{-3}	1×10^{-3}	1×10^0	1×10^3
Clor()-Klor				
Cl-36	1×10^1	6×10^{-1}	1×10^4	1×10^6
Cl-38	2×10^{-1}	2×10^{-1}	1×10^1	1×10^5
Curium (96)-Küryum				
Cm-240	4×10^1	2×10^{-2}	1×10^2	1×10^5
Cm-241	2×10^0	1×10^0	1×10^2	1×10^6
Cm-242	4×10^1	1×10^{-2}	1×10^2	1×10^5
Cm-243	9×10^0	1×10^{-3}	1×10^0	1×10^4
Cm-244	2×10^1	2×10^{-3}	1×10^1	1×10^4
Cm-245	9×10^0	9×10^{-4}	1×10^0	1×10^3
Cm-246	9×10^0	9×10^{-4}	1×10^0	1×10^3
Cm-247 (a)	3×10^0	1×10^{-3}	1×10^0	1×10^4
Cm-248	2×10^{-2}	3×10^{-4}	1×10^0	1×10^3
Cobalt (27)-Kobalt				
Co-55	5×10^{-1}	5×10^{-1}	1×10^1	1×10^6
Co-56	3×10^{-1}	3×10^{-1}	1×10^1	1×10^5

Co-57	1×10^1	1×10^1	1×10^2	1×10^6
Co-58	1×10^0	1×10^0	1×10^1	1×10^6
Co-58m	4×10^1	4×10^1	1×10^4	1×10^7
Co-60	4×10^{-1}	4×10^{-1}	1×10^1	1×10^5
Chromium (24)-Krom				
Cr-51	3×10^1	3×10^1	1×10^3	1×10^7
Caesium (55)-Sezyum				
Cs-129	4×10^0	4×10^0	1×10^2	1×10^5
Cs-131	3×10^1	3×10^1	1×10^3	1×10^6
Cs-132	1×10^0	1×10^0	1×10^1	1×10^5
Cs-134	7×10^{-1}	7×10^{-1}	1×10^1	1×10^4
Cs-134m	4×10^1	6×10^{-1}	1×10^3	1×10^5
Cs-135	4×10^1	1×10^0	1×10^4	1×10^7
Cs-136	5×10^{-1}	5×10^{-1}	1×10^1	1×10^5
Cs-137 (a)	2×10^0	6×10^{-1}	$1 \times 10^1(b)$	$1 \times 10^4(b)$
Copper (29)-Bakır				
Cu-64	6×10^0	1×10^0	1×10^2	1×10^6
Cu-67	1×10^1	7×10^{-1}	1×10^2	1×10^6
Dysprosium (66)-Disprosyum				
Dy-159	2×10^1	2×10^1	1×10^3	1×10^7
Dy-165	9×10^{-1}	6×10^{-1}	1×10^3	1×10^6
Dy-166 (a)	9×10^{-1}	3×10^{-1}	1×10^3	1×10^6
Erbium (68)Erbiyum				
Er-169	4×10^1	1×10^0	1×10^4	1×10^7
Er-171	8×10^{-1}	5×10^{-1}	1×10^2	1×10^6
Europium (63)-Öropiyum				
Eu-147	2×10^0	2×10^0	1×10^2	1×10^6
Eu-148	5×10^{-1}	5×10^{-1}	1×10^1	1×10^6
Eu-149	2×10^1	2×10^1	1×10^2	1×10^7
Eu-150 (kısa yarı ömürlü)	2×10^0	7×10^{-1}	1×10^3	1×10^6
Eu-150 (uzun yarı ömürlü)	7×10^{-1}	7×10^{-1}	1×10^1	1×10^6
Eu-152	1×10^0	1×10^0	1×10^1	1×10^6
Eu-152m	8×10^{-1}	8×10^{-1}	1×10^2	1×10^6
Eu-154	9×10^{-1}	6×10^{-1}	1×10^1	1×10^6
Eu-155	2×10^1	3×10^0	1×10^2	1×10^7
Eu-156	7×10^{-1}	7×10^{-1}	1×10^1	1×10^6
Fluorine (9)-Flor				
F-18	1×10^0	6×10^{-1}	1×10^1	1×10^6
Iron (26)-Demir				
Fe-52 (a)	3×10^{-1}	3×10^{-1}	1×10^1	1×10^6
Fe-55	4×10^1	4×10^1	1×10^4	1×10^6
Fe-59	9×10^{-1}	9×10^{-1}	1×10^1	1×10^6
Fe-60 (a)	4×10^1	2×10^{-1}	1×10^2	1×10^5
Gallium (31)-Galyum				
Ga-67	7×10^0	3×10^0	1×10^2	1×10^6
Ga-68	5×10^{-1}	5×10^{-1}	1×10^1	1×10^5
Ga-72	4×10^{-1}	4×10^{-1}	1×10^1	1×10^5
Gadolinium (64)-Gadolinyum				
Gd-146 (a)	5×10^{-1}	5×10^{-1}	1×10^1	1×10^6
Gd-148	2×10^1	2×10^{-3}	1×10^1	1×10^4
Gd-153	1×10^1	9×10^0	1×10^2	1×10^7

Gd-159	3×10^0	6×10^{-1}	1×10^3	1×10^6
Germanium (32)-Germanyum				
Ge-68 (a)	5×10^{-1}	5×10^{-1}	1×10^1	1×10^5
Ge-71	4×10^1	4×10^1	1×10^4	1×10^8
Ge-77	3×10^{-1}	3×10^{-1}	1×10^1	1×10^5
Hafnium (72)-Hafniyum				
Hf-172 (a)	6×10^{-1}	6×10^{-1}	1×10^1	1×10^6
Hf-175	3×10^0	3×10^0	1×10^2	1×10^6
Hf-181	2×10^0	5×10^{-1}	1×10^1	1×10^6
Hf-182	Sınırsız	Sınırsız	1×10^2	1×10^6
Mercury (80)-Civa				
Hg-194 (a)	1×10^0	1×10^0	1×10^1	1×10^6
Hg-195m (a)	3×10^0	7×10^{-1}	1×10^2	1×10^6
Hg-197	2×10^1	1×10^1	1×10^2	1×10^7
Hg-197m	1×10^1	4×10^{-1}	1×10^2	1×10^6
Hg-203	5×10^0	1×10^0	1×10^2	1×10^5
Holmium (67)-Holmiyum				
Ho-166	4×10^{-1}	4×10^{-1}	1×10^3	1×10^5
Ho-166m	6×10^{-1}	5×10^{-1}	1×10^1	1×10^6
Iodine (53)-İyot				
I-123	6×10^0	3×10^0	1×10^2	1×10^7
I-124	1×10^0	1×10^0	1×10^1	1×10^6
I-125	2×10^1	3×10^0	1×10^3	1×10^6
I-126	2×10^0	1×10^0	1×10^2	1×10^6
I-129	Sınırsız	Sınırsız	1×10^2	1×10^5
I-131	3×10^0	7×10^{-1}	1×10^2	1×10^6
I-132	4×10^{-1}	4×10^{-1}	1×10^1	1×10^5
I-133	7×10^{-1}	6×10^{-1}	1×10^1	1×10^6
I-134	3×10^{-1}	3×10^{-1}	1×10^1	1×10^5
I-135 (a)	6×10^{-1}	6×10^{-1}	1×10^1	1×10^6
Indium (49)-İndiyum				
In-111	3×10^0	3×10^0	1×10^2	1×10^6
In-113m	4×10^0	2×10^0	1×10^2	1×10^6
In-114m (a)	1×10^1	5×10^{-1}	1×10^2	1×10^6
In-115m	7×10^0	1×10^0	1×10^2	1×10^6
Iridium (77)-İridiyum				
Ir-189 (a)	1×10^1	1×10^1	1×10^2	1×10^7
Ir-190	7×10^{-1}	7×10^{-1}	1×10^1	1×10^6
Ir-192	1×10^0 (c)	6×10^{-1}	1×10^1	1×10^4
Ir-194	3×10^{-1}	3×10^{-1}	1×10^2	1×10^5
Potassium (19)-Potasyum				
K-40	9×10^{-1}	9×10^{-1}	1×10^2	1×10^6
K-42	2×10^{-1}	2×10^{-1}	1×10^2	1×10^6
K-43	7×10^{-1}	6×10^{-1}	1×10^1	1×10^6
Krypton (36)-Kripton				
Kr-81	4×10^1	4×10^1	1×10^4	1×10^7
Kr-85	1×10^1	1×10^1	1×10^5	1×10^4
Kr-85m	8×10^0	3×10^0	1×10^3	1×10^{10}
Kr-87	2×10^{-1}	2×10^{-1}	1×10^2	1×10^9
Lanthanum (57)-Lantan				
La-137	3×10^1	6×10^0	1×10^3	1×10^7

La-140	4×10^{-1}	4×10^{-1}	1×10^1	1×10^5
Lutetium (71)-Lutesyum				
Lu-172	6×10^{-1}	6×10^{-1}	1×10^1	1×10^6
Lu-173	8×10^0	8×10^0	1×10^2	1×10^7
Lu-174	9×10^0	9×10^0	1×10^2	1×10^7
Lu-174m	2×10^1	1×10^1	1×10^2	1×10^7
Lu-177	3×10^1	7×10^{-1}	1×10^3	1×10^7
Magnesium (12)-Mağnezyum				
Mg-28 (a)	3×10^{-1}	3×10^{-1}	1×10^1	1×10^5
Manganese (25)-Mangan				
Mn-52	3×10^{-1}	3×10^{-1}	1×10^1	1×10^5
Mn-53	Sınırsız	Sınırsız	1×10^4	1×10^9
Mn-54	1×10^0	1×10^0	1×10^1	1×10^6
Mn-56	3×10^{-1}	3×10^{-1}	1×10^1	1×10^5
Molybdenum (42)-Molibden				
Mo-93	4×10^1	2×10^1	1×10^3	1×10^8
Mo-99 (a)	1×10^0	6×10^{-1}	1×10^2	1×10^6
Nitrogen (7)-Azot				
N-13	9×10^{-1}	6×10^{-1}	1×10^2	1×10^9
Sodium (11)-Sodyum				
Na-22	5×10^{-1}	5×10^{-1}	1×10^1	1×10^6
Na-24	2×10^{-1}	2×10^{-1}	1×10^1	1×10^5
Niobium (41)-Niyobiyum				
Nb-93m	4×10^1	3×10^1	1×10^4	1×10^7
Nb-94	7×10^{-1}	7×10^{-1}	1×10^1	1×10^6
Nb-95	1×10^0	1×10^0	1×10^1	1×10^6
Nb-97	9×10^{-1}	6×10^{-1}	1×10^1	1×10^6
Neodymium (60)Neodimiyum				
Nd-147	6×10^0	6×10^{-1}	1×10^2	1×10^6
Nd-149	6×10^{-1}	5×10^{-1}	1×10^2	1×10^6
Nickel (28)-Nikel				
Ni-59	Sınırsız	Sınırsız	1×10^4	1×10^8
Ni-63	4×10^1	3×10^1	1×10^5	1×10^8
Ni-65	4×10^{-1}	4×10^{-1}	1×10^1	1×10^6
Neptunium (93)-Neptünyum				
Np-235	4×10^1	4×10^1	1×10^3	1×10^7
Np-236 (kısa yarı ömürlü)	2×10^1	2×10^0	1×10^3	1×10^7
Np-236 (uzun yarı ömürlü)	9×10^0	2×10^{-2}	1×10^2	1×10^5
Np-237	2×10^1	2×10^{-3}	$1 \times 10^0(b)$	$1 \times 10^3(b)$
Np-239	7×10^0	4×10^{-1}	1×10^2	1×10^7
Osmium (76)-Osmiyum				
Os-185	1×10^0	1×10^0	1×10^1	1×10^6
Os-191	1×10^1	2×10^0	1×10^2	1×10^7
Os-191m	4×10^1	3×10^1	1×10^3	1×10^7
Os-193	2×10^0	6×10^{-1}	1×10^2	1×10^6
Os-194 (a)	3×10^{-1}	3×10^{-1}	1×10^2	1×10^5
Phosphorus (15)-Fosfor				
P-32	5×10^{-1}	5×10^{-1}	1×10^3	1×10^5
P-33	4×10^1	1×10^0	1×10^5	1×10^8
Protactinium (91)-Protaktinyum				
Pa-230 (a)	2×10^0	7×10^{-2}	1×10^1	1×10^6

Pa-231	4×10^0	4×10^{-4}	1×10^0	1×10^3
Pa-233	5×10^0	7×10^{-1}	1×10^2	1×10^7
Lead (82)-Kurşun				
Pb-201	1×10^0	1×10^0	1×10^1	1×10^6
Pb-202	4×10^1	2×10^1	1×10^3	1×10^6
Pb-203	4×10^0	3×10^0	1×10^2	1×10^6
Pb-205	Sınırsız	Sınırsız	1×10^4	1×10^7
Pb-210 (a)	1×10^0	5×10^{-2}	$1 \times 10^1(b)$	$1 \times 10^4(b)$
Pb-212 (a)	7×10^{-1}	2×10^{-1}	$1 \times 10^1(b)$	$1 \times 10^5(b)$
Palladium (46)-Paladyum				
Pd-103 (a)	4×10^1	4×10^1	1×10^3	1×10^8
Pd-107	Sınırsız	Sınırsız	1×10^5	1×10^8
Pd-109	2×10^0	5×10^{-1}	1×10^3	1×10^6
Promethium (61)-Prometyum				
Pm-143	3×10^0	3×10^0	1×10^2	1×10^6
Pm-144	7×10^{-1}	7×10^{-1}	1×10^1	1×10^6
Pm-145	3×10^1	1×10^1	1×10^3	1×10^7
Pm-147	4×10^1	2×10^0	1×10^4	1×10^7
Pm-148m (a)	8×10^{-1}	7×10^{-1}	1×10^1	1×10^6
Pm-149	2×10^0	6×10^{-1}	1×10^3	1×10^6
Pm-151	2×10^0	6×10^{-1}	1×10^2	1×10^6
Polonium (84)-Polonyum				
Po-210	4×10^1	2×10^{-2}	1×10^1	1×10^4
Praseodymium (59)-Praseodimyum				
Pr-142	4×10^{-1}	4×10^{-1}	1×10^2	1×10^5
Pr-143	3×10^0	6×10^{-1}	1×10^4	1×10^6
Platinum (78)-Platin				
Pt-188 (a)	1×10^0	8×10^{-1}	1×10^1	1×10^6
Pt-191	4×10^0	3×10^0	1×10^2	1×10^6
Pt-193	4×10^1	4×10^1	1×10^4	1×10^7
Pt-193m	4×10^1	5×10^{-1}	1×10^3	1×10^7
Pt-195m	1×10^1	5×10^{-1}	1×10^2	1×10^6
Pt-197	2×10^1	6×10^{-1}	1×10^3	1×10^6
Pt-197m	1×10^1	6×10^{-1}	1×10^2	1×10^6
Plutonium (94)-Plütonyum				
Pu-236	3×10^1	3×10^{-3}	1×10^1	1×10^4
Pu-237	2×10^1	2×10^1	1×10^3	1×10^7
Pu-238	1×10^1	1×10^{-3}	1×10^0	1×10^4
Pu-239	1×10^1	1×10^{-3}	1×10^0	1×10^4
Pu-240	1×10^1	1×10^{-3}	1×10^0	1×10^3
Pu-241 (a)	4×10^1	6×10^{-2}	1×10^2	1×10^5
Pu-242	1×10^1	1×10^{-3}	1×10^0	1×10^4
Pu-244 (a)	4×10^{-1}	1×10^{-3}	1×10^0	1×10^4
Radium (88)-Radyum				
Ra-223 (a)	4×10^{-1}	7×10^{-3}	$1 \times 10^2(b)$	$1 \times 10^5(b)$
Ra-224 (a)	4×10^{-1}	2×10^{-2}	$1 \times 10^1(b)$	$1 \times 10^5(b)$
Ra-225 (a)	2×10^{-1}	4×10^{-3}	1×10^2	1×10^5
Ra-226 (a)	2×10^{-1}	3×10^{-3}	$1 \times 10^1(b)$	$1 \times 10^4(b)$
Ra-228 (a)	6×10^{-1}	2×10^{-2}	$1 \times 10^1(b)$	$1 \times 10^5(b)$
Rubidium (37)-Rubidyum				
Rb-81	2×10^0	8×10^{-1}	1×10^1	1×10^6

Rb-83 (a)	2×10^0	2×10^0	1×10^2	1×10^6
Rb-84	1×10^0	1×10^0	1×10^1	1×10^6
Rb-86	5×10^{-1}	5×10^{-1}	1×10^2	1×10^5
Rb-87	Sınırsız	Sınırsız	1×10^4	1×10^7
Rb (doğ)	Sınırsız	Sınırsız	1×10^4	1×10^7
Rhenium (75)-Renyum				
Re-184	1×10^0	1×10^0	1×10^1	1×10^6
Re-184m	3×10^0	1×10^0	1×10^2	1×10^6
Re-186	2×10^0	6×10^{-1}	1×10^3	1×10^6
Re-187	Sınırsız	Sınırsız	1×10^6	1×10^9
Re-188	4×10^{-1}	4×10^{-1}	1×10^2	1×10^5
Re-189 (a)	3×10^0	6×10^{-1}	1×10^2	1×10^6
Re (doğ)	Sınırsız	Sınırsız	1×10^6	1×10^9
Rhodium (45)-Rodyum				
Rh-99	2×10^0	2×10^0	1×10^1	1×10^6
Rh-101	4×10^0	3×10^0	1×10^2	1×10^7
Rh-102	5×10^{-1}	5×10^{-1}	1×10^1	1×10^6
Rh-102m	2×10^0	2×10^0	1×10^2	1×10^6
Rh-103m	4×10^1	4×10^1	1×10^4	1×10^8
Rh-105	1×10^1	8×10^{-1}	1×10^2	1×10^7
Radon (86)-Radon				
Rn-222 (a)	3×10^{-1}	4×10^{-3}	$1 \times 10^1(b)$	$1 \times 10^8(b)$
Ruthenium (44)-Rutenyum				
Ru-97	5×10^0	5×10^0	1×10^2	1×10^7
Ru-103 (a)	2×10^0	2×10^0	1×10^2	1×10^6
Ru-105	1×10^0	6×10^{-1}	1×10^1	1×10^6
Ru-106 (a)	2×10^{-1}	2×10^{-1}	$1 \times 10^2(b)$	$1 \times 10^5(b)$
Sulphur (16)-Kükürt				
S-35	4×10^1	3×10^0	1×10^5	1×10^8
Antimony (51)-Antimon				
Sb-122	4×10^{-1}	4×10^{-1}	1×10^2	1×10^4
Sb-124	6×10^{-1}	6×10^{-1}	1×10^1	1×10^6
Sb-125	2×10^0	1×10^0	1×10^2	1×10^6
Sb-126	4×10^{-1}	4×10^{-1}	1×10^1	1×10^5
Scandium (21)-Skandiyum				
Sc-44	5×10^{-1}	5×10^{-1}	1×10^1	1×10^5
Sc-46	5×10^{-1}	5×10^{-1}	1×10^1	1×10^6
Sc-47	1×10^1	7×10^{-1}	1×10^2	1×10^6
Sc-48	3×10^{-1}	3×10^{-1}	1×10^1	1×10^5
Selenium (34)-Selenyum				
Se-75	3×10^0	3×10^0	1×10^2	1×10^6
Se-79	4×10^1	2×10^0	1×10^4	1×10^7
Silicon (14)-Silikon				
Si-31	6×10^{-1}	6×10^{-1}	1×10^3	1×10^6
Si-32	4×10^1	5×10^{-1}	1×10^3	1×10^6
Samarium (62)-Samaryum				
Sm-145	1×10^1	1×10^1	1×10^2	1×10^7
Sm-147	Sınırsız	Sınırsız	1×10^1	1×10^4
Sm-151	4×10^1	1×10^1	1×10^4	1×10^8
Sm-153	9×10^0	6×10^{-1}	1×10^2	1×10^6
Tin (50)				

Sn-113 (a)	4×10^0	2×10^0	1×10^3	1×10^7
Sn-117m	7×10^0	4×10^{-1}	1×10^2	1×10^6
Sn-119m	4×10^1	3×10^1	1×10^3	1×10^7
Sn-121m (a)	4×10^1	9×10^{-1}	1×10^3	1×10^7
Sn-123	8×10^{-1}	6×10^{-1}	1×10^3	1×10^6
Sn-125	4×10^{-1}	4×10^{-1}	1×10^2	1×10^5
Sn-126 (a)	6×10^{-1}	4×10^{-1}	1×10^1	1×10^5
Strontium (38)-Stronsiyum				
Sr-82 (a)	2×10^{-1}	2×10^{-1}	1×10^1	1×10^5
Sr-85	2×10^0	2×10^0	1×10^2	1×10^6
Sr-85m	5×10^0	5×10^0	1×10^2	1×10^7
Sr-87m	3×10^0	3×10^0	1×10^2	1×10^6
Sr-89	6×10^{-1}	6×10^{-1}	1×10^3	1×10^6
Sr-90 (a)	3×10^{-1}	3×10^{-1}	1×10^2 (b)	1×10^4 (b)
Sr-91 (a)	3×10^{-1}	3×10^{-1}	1×10^1	1×10^5
Sr-92 (a)	1×10^0	3×10^{-1}	1×10^1	1×10^6
Tritium (1)-Tritiyum				
T (H-3)	4×10^1	4×10^1	1×10^6	1×10^9
Tantalum (73)				
Ta-178 (uzun yarı ömürlü)	1×10^0	8×10^{-1}	1×10^1	1×10^6
Ta-179	3×10^1	3×10^1	1×10^3	1×10^7
Ta-182	9×10^{-1}	5×10^{-1}	1×10^1	1×10^4
Terbium (65)-Terbiyum				
Tb-157	4×10^1	4×10^1	1×10^4	1×10^7
Tb-158	1×10^0	1×10^0	1×10^1	1×10^6
Tb-160	1×10^0	6×10^{-1}	1×10^1	1×10^6
Technetium (43)-Teknesyum				
Tc-95m (a)	2×10^0	2×10^0	1×10^1	1×10^6
Tc-96	4×10^{-1}	4×10^{-1}	1×10^1	1×10^6
Tc-96m (a)	4×10^{-1}	4×10^{-1}	1×10^3	1×10^7
Tc-97	Sınırsız	Sınırsız	1×10^3	1×10^8
Tc-97m	4×10^1	1×10^0	1×10^3	1×10^7
Tc-98	8×10^{-1}	7×10^{-1}	1×10^1	1×10^6
Tc-99	4×10^1	9×10^{-1}	1×10^4	1×10^7
Tc-99m	1×10^1	4×10^0	1×10^2	1×10^7
Tellurium (52)-Tellür				
Te-121	2×10^0	2×10^0	1×10^1	1×10^6
Te-121m	5×10^0	3×10^0	1×10^2	1×10^5
Te-123m	8×10^0	1×10^0	1×10^2	1×10^7
Te-125m	2×10^1	9×10^{-1}	1×10^3	1×10^7
Te-127	2×10^1	7×10^{-1}	1×10^3	1×10^6
Te-127m (a)	2×10^1	5×10^{-1}	1×10^3	1×10^7
Te-129	7×10^{-1}	6×10^{-1}	1×10^2	1×10^6
Te-129m (a)	8×10^{-1}	4×10^{-1}	1×10^3	1×10^6
Te-131m (a)	7×10^{-1}	5×10^{-1}	1×10^1	1×10^6
Te-132 (a)	5×10^{-1}	4×10^{-1}	1×10^2	1×10^7
Thorium (90)-Toryum				
Th-227	1×10^1	5×10^{-3}	1×10^1	1×10^4
Th-228 (a)	5×10^{-1}	1×10^{-3}	1×10^0 (b)	1×10^4 (b)
Th-229	5×10^0	5×10^{-4}	1×10^0 (b)	1×10^3 (b)
Th-230	1×10^1	1×10^{-3}	1×10^0	1×10^4

Th-231	4×10^1	2×10^{-2}	1×10^3	1×10^7
Th-232	Sınırsız	Sınırsız	1×10^1	1×10^4
Th-234 (a)	3×10^{-1}	3×10^{-1}	$1 \times 10^3(b)$	$1 \times 10^5(b)$
Th (doğ)	Sınırsız	Sınırsız	$1 \times 10^0(b)$	$1 \times 10^3(b)$
Titanium (22)-Titanyum				
Ti-44 (a)	5×10^{-1}	4×10^{-1}	1×10^1	1×10^5
Thallium (81)-Talyum				
Tl-200	9×10^{-1}	9×10^{-1}	1×10^1	1×10^6
Tl-201	1×10^1	4×10^0	1×10^2	1×10^6
Tl-202	2×10^0	2×10^0	1×10^2	1×10^6
Tl-204	1×10^1	7×10^{-1}	1×10^4	1×10^4
Thulium (69)-Tulyum				
Tm-167	7×10^0	8×10^{-1}	1×10^2	1×10^6
Tm-170	3×10^0	6×10^{-1}	1×10^3	1×10^6
Tm-171	4×10^1	4×10^1	1×10^4	1×10^8
Uranium (92)-Uranyum				
U-230 (akciğerde hızlı soğurulma)(a)(d)	4×10^1	1×10^{-1}	$1 \times 10^1(b)$	$1 \times 10^5(b)$
U-230 (akciğerde orta hızlı soğurulma)(a)(e)	4×10^1	4×10^{-3}	1×10^1	1×10^4
U-230 (akciğerde yavaş soğurulma)(a)(f)	3×10^1	3×10^{-3}	1×10^1	1×10^4
U-232 (akciğerde hızlı soğurulma)(d)	4×10^1	1×10^{-2}	$1 \times 10^0(b)$	$1 \times 10^3(b)$
U-232 (akciğerde orta hızlı soğurulma)(e)	4×10^1	7×10^{-3}	1×10^1	1×10^4
U-232 (akciğerde yavaş soğurulma)(f)	1×10^1	1×10^{-3}	1×10^1	1×10^4
U-233 (akciğerde hızlı soğurulma)(d)	4×10^1	9×10^{-2}	1×10^1	1×10^4
U-233 (akciğerde orta hızlı soğurulma)(e)	4×10^1	2×10^{-2}	1×10^2	1×10^5
U-233 (akciğerde yavaş soğurulma)(f)	4×10^1	6×10^{-3}	1×10^1	1×10^5
U-234 (akciğerde hızlı soğurulma)(d)	4×10^1	9×10^{-2}	1×10^1	1×10^4
U-234 (akciğerde orta hızlı soğurulma)(e)	4×10^1	2×10^{-2}	1×10^2	1×10^5
U-234 (akciğerde yavaş soğurulma)(f)	4×10^1	6×10^{-3}	1×10^1	1×10^5
U-235 (akciğerdeki tüm soğurulma tipleri)(a),(d),(e),(f)	Sınırsız	Sınırsız	$1 \times 10^1(b)$	$1 \times 10^4(b)$
U-236 (akciğerde hızlı soğurulma)(d)	Sınırsız	Sınırsız	1×10^1	1×10^4
U-236 (akciğerde orta hızlı soğurulma)(e)	4×10^1	2×10^{-2}	1×10^2	1×10^5
U-236 (akciğerde yavaş soğurulma)(f)	4×10^1	6×10^{-3}	1×10^1	1×10^4
U-238 (akciğerdeki tüm Soğurulma tipleri)(d), (e), (f)	Sınırsız	Sınırsız	$1 \times 10^1(b)$	$1 \times 10^4(b)$
U (doğ)	Sınırsız	Sınırsız	$1 \times 10^0(b)$	$1 \times 10^3(b)$
U (%20'ye kadar veya daha az	Sınırsız	Sınırsız	1×10^0	1×10^3

zenginleştirilmiş) (g)				
U (tüük)	Sınırsız	Sınırsız	1×10^0	1×10^3
Vanadium (23)-Vanadyum				
V-48	4×10^{-1}	4×10^{-1}	1×10^1	1×10^5
V-49	4×10^1	4×10^1	1×10^4	1×10^7
Tungsten (74)-Tungsten				
W-178 (a)	9×10^0	5×10^0	1×10^1	1×10^6
W-181	3×10^1	3×10^1	1×10^3	1×10^7
W-185	4×10^1	8×10^{-1}	1×10^4	1×10^7
W-187	2×10^0	6×10^{-1}	1×10^2	1×10^6
W-188 (a)	4×10^{-1}	3×10^{-1}	1×10^2	1×10^5
Xenon (54)-Ksenon				
Xe-122 (a)	4×10^{-1}	4×10^{-1}	1×10^2	1×10^9
Xe-123	2×10^0	7×10^{-1}	1×10^2	1×10^9
Xe-127	4×10^0	2×10^0	1×10^3	1×10^5
Xe-131m	4×10^1	4×10^1	1×10^4	1×10^4
Xe-133	2×10^1	1×10^1	1×10^3	1×10^4
Xe-135	3×10^0	2×10^0	1×10^3	1×10^{10}
Yttrium (39)-İttriyum				
Y-87 (a)	1×10^0	1×10^0	1×10^1	1×10^6
Y-88	4×10^{-1}	4×10^{-1}	1×10^1	1×10^6
Y-90	3×10^{-1}	3×10^{-1}	1×10^3	1×10^5
Y-91	6×10^{-1}	6×10^{-1}	1×10^3	1×10^6
Y-91m	2×10^0	2×10^0	1×10^2	1×10^6
Y-92	2×10^{-1}	2×10^{-1}	1×10^2	1×10^5
Y-93	3×10^{-1}	3×10^{-1}	1×10^2	1×10^5
Ytterbium (70)-İtterbiyum				
Yb-169	4×10^0	1×10^0	1×10^2	1×10^7
Yb-175	3×10^1	9×10^{-1}	1×10^3	1×10^7
Zinc (30)-Çinko				
Zn-65	2×10^0	2×10^0	1×10^1	1×10^6
Zn-69	3×10^0	6×10^{-1}	1×10^4	1×10^6
Zn-69m (a)	3×10^0	6×10^{-1}	1×10^2	1×10^6
Zirconium (40)-Zirkonyum				
Zr-88	3×10^0	3×10^0	1×10^2	1×10^6
Zr-93	Sınırsız	Sınırsız	$1 \times 10^3(b)$	$1 \times 10^7(b)$
Zr-95 (a)	2×10^0	8×10^{-1}	1×10^1	1×10^6
Zr-97 (a)	4×10^{-1}	4×10^{-1}	$1 \times 10^1(b)$	$1 \times 10^5(b)$

(a) A_1 ve, veya A_2 değerleri yarı ömürleri 10 günden az olan ürün radyoizotoplardan gelen katkıyı da içerir

(b) Ürün radyoizotopları ile dengede olan radyoizotoplar aşağıda listelenmiştir.

Sr-90	Y-90			
Zr-93	Nb-93m			
Zr-97	Nb-97			
Ru-106	Rh-106			
Cs-137	Ba-137m			
Ce-134	La-134			
Ce-144	Pr-144			
Ba-140	La-140			

Bi-212	Tl-208 (0.36), Po-212 (0.64)			
Pb-210	Bi-210, Po-210			
Pb-212	Bi-212, Tl-208 (0.36), Po-212 (0.64)			
Rn-220	Po-216			
Rn-222	Po-218, Pb-214, Bi-214, Po-214			
Ra-223	Rn-219, Po-215, Pb-211, Bi-211, Tl-207			
Ra-224	Rn-220, Po-216, Pb-212, Bi-212, Tl-208 (0.36), Po-212 (0.64)			
Ra-226	Rn-222, Po-218, Pb-214, Bi-214, Po-214, Pb-210, Bi-210, Po-210			
Ra-228	Ac-228			
Th-226	Ra-222, Rn-218, Po-214			
Th-228	Ra-224, Rn-220, Po-216, Pb-212, Bi-212, Tl-208 (0.36), Po-212 (0.64)			
Th-229	Ra-225, Ac-225, Fr-221, At-217, Bi-213, Po-213, Pb-209			
Th-doğ	Ra-228, Ac-228, Th-228, Ra-224, Rn-220, Po-216, Pb-212, Bi-212,			
	Tl-208 (0.36), Po-212 (0.64)			
Th-234	Pa-234m			
U-230	Th-226, Ra-222, Rn-218, Po-214			
U-232	Th-228, Ra-224, Rn-220, Po-216, Pb-212, Bi-212, Tl-208 (0.36) Po-212 (0.64)			
U-235	Th-231			
U-238	Th-234, Pa-234m			
U-doğ	Th-234, Pa-234m, U-234, Th-230, Ra-226, Rn-222, Po-218, Pb-214, Bi-214, Po-214, Pb-210, Bi-210, Po-210			
U-240	Np-240m			
Np-237	Pa-233			
Am-242m	Am-242			
Am-243	Np-239			

- (c) Radyoaktivite değeri kaynağa belli bir mesafeden bozunma hızı ya da radyasyon seviyesinin ölçülmesi ile belirlenebilir.
- (d) Bu değerler normal taşıma ve kaza koşullarında uranyumun UF₆, UO₂F₂ ve UO₂(NO₃)₂ kimyasal formundaki bileşiklerine uygulanır.
- (e) Bu değerler normal taşıma ve kaza koşullarında uranyumun UO₃, UF₄, UCl₄ kimyasal formundaki ve altı değerlikli bileşiklerine uygulanır.
- (f) Bu değerler uranyumun (d) ve (e)'de belirtilenlerin dışında kalan tüm bileşiklerine uygulanır
- (g) Bu değerler sadece ışınlanmamış uranyuma uygulanır.

TABLO 2- A₁ VE A₂ İÇİN GENEL DEĞERLER

İçindekiler	A ₁	A ₂	Muaf madde için radyoaktivite konsantrasyonu	Muaf sevkiyat için radyoaktivite sınırı
	TBq	TBq	Bq/g	Bq
yalnızca β veya γ yayıcı radyoizotopların varlığı biliniyorsa	0.1	0.02	1x10 ¹	1x10 ⁴
yalnızca α yayıcı izotopların varlığı biliniyorsa	0.2	9x10 ⁻⁵	1x10 ⁻¹	1x10 ³
bilgi yoksa	0.001	9x10 ⁻⁵	1x10 ⁻¹	1x10 ³

TABLO 3- ADİ PAKETLER İÇİN SINIR DEĞERLERİ

Paket Muhtevasının Fiziksel Durumu	Radyoaktivite Sınırı		
	Cihaz ya da Mamul Madde		Madde
	Parça başına sınır değeri	Paket için toplam sınır değeri	Paket için sınır değeri
Katılar			
Özel Hazırlanmış	10 ⁻² A ₁	A ₁	10 ⁻³ A ₁
Özel Hazırlanmış Olmayan	10 ⁻² A ₂	A ₂	10 ⁻³ A ₂
Sıvılar	10 ⁻³ A ₂	10 ⁻¹ A ₂	10 ⁻⁴ A ₂
Gazlar			
Özel Hazırlanmış	10 ⁻³ A ₁	10 ⁻² A ₁	10 ⁻³ A ₁
Özel Hazırlanmış Olmayan	10 ⁻³ A ₂	10 ⁻² A ₂	10 ⁻³ A ₂
Trityum	2x10 ⁻² A ₂	2x10 ⁻² A ₂	2x10 ⁻² A ₂

TABLO 4- LSA MADDE VE SCO İÇİN ENDÜSTRİYEL PAKET TİPLERİ

Madde	Endüstriyel Paket tipleri	
	Özel koşullu taşıma	Özel koşullu taşıma dışında
LSA - I		
Katı	IP-1	IP-1
Sıvı	IP-1	IP-2
LSA - II		
Katı	IP-2	IP-2
Sıvı ve Gaz	IP-2	IP-3
LSA - III	IP-2	IP-3
SCO - I	IP-1	IP-1
SCO - II	IP-2	IP-2

TABLO 5- LSA MADDE VE SCO TAŞINMASINDA SINIR DEĞERLERİ

Maddenin Cinsi	Taşıma aracı için sınır değeri (ülke içi su yolu taşıması hariç)	Ülke içi su yolu taşımasında geminin bir ambar veya taşıma bölümü için sınır değeri
LSA-I	Sınırsız	Sınırsız
LSA-II ve LSA-III yanıcı olmayan katı	Sınırsız	100 A ₂
LSA-II VE LSA-III yanıcı katı ve bütün sıvı ve gazlar	100 A ₂	10 A ₂
SCO	100 A ₂	10 A ₂

TABLO 6- BÜYÜK BOYUTLU YÜKLER İÇİN TI ÇARPIM FAKTÖRLERİ

Tank, taşıma kabı ve paketlenmemiş LSA-1, SCO-I yük boyutları *	
Yük boyutu	Çarpım faktörü
1 m ² ve daha küçük	1
1 m ² -5 m ²	2
5 m ² -20 m ²	3
20 m ² 'den büyük	10

* Yükün en geniş kesit alanı ölçülür.

TABLO 7- PAKET SINIFLARI

Şartlar		Sınıf
Taşıma indisi (TI)	Yüzeyin herhangi bir noktasında en yüksek radyasyon seviyesi	
0	≤ 0.005 mSv/h	I - BEYAZ
0-1	0.005 mSv/h-0.5 mSv/h	II - SARI
1-10	0.5 mSv/h-2 mSv/h	III - SARI
> 10	2 mSv/h-10 mSv/h	III - SARI ve Özel Koşullu

TABLO 8- KONTEYNER ve TAŞIMA ARAÇLARI İÇİN TI SINIR DEĞERLERİ

Taşıma kabı veya taşıma araçları	Toplam TI sınırı
Küçük taşıma kabı	50
Büyük taşıma kabı	50
Kara Aracı	50
Yolcu uçağı	50
Kargo uçağı	200
Gemide bir bölmede, ambarda veya güvertede taşınan paket, koli, küçük taşıma kapları veya büyük taşıma kapları	50
Gemideki bütün paketler	200
Büyük taşıma kapları	sınırsız

TABLO 9- TAŞIMA KAPLARI VE TAŞIMA ARAÇLARI İÇİN CSI DEĞERLERİ

Taşıma Kabı veya taşıma araçları	Toplam CSI sınırı	
	Özel koşullu olmayan	Özel koşullu
	Bölünebilir madde	Bölünebilir madde
Küçük taşıma kabı	50	uygulanmaz
Büyük taşıma kabı	50	100
Kara Aracı	50	100
Yolcu uçağı	50	uygulanmaz
Kargo uçağı	50	100
Gemide bir bölmede, ambarda veya güvertede taşınan paket, koli, küçük taşıma kapları	50	100
Büyük taşıma kapları	50	100
Gemideki bütün paketler	200	200
Büyük taşıma kapları	sınırsız	sınırsız

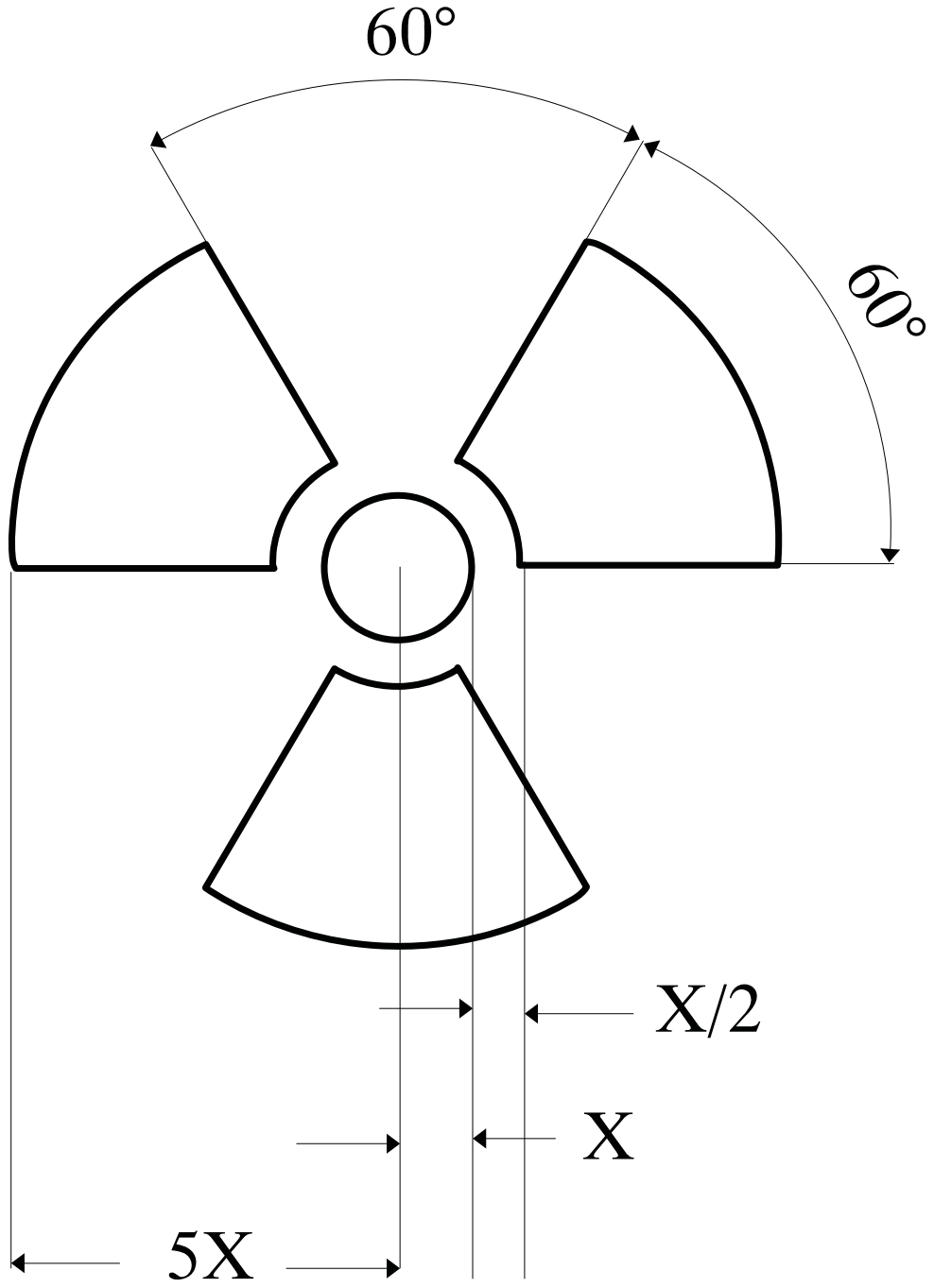

ŞEKİL 1 - Radyasyon Simgesi (X için en küçük değer 4 mm olacaktır)

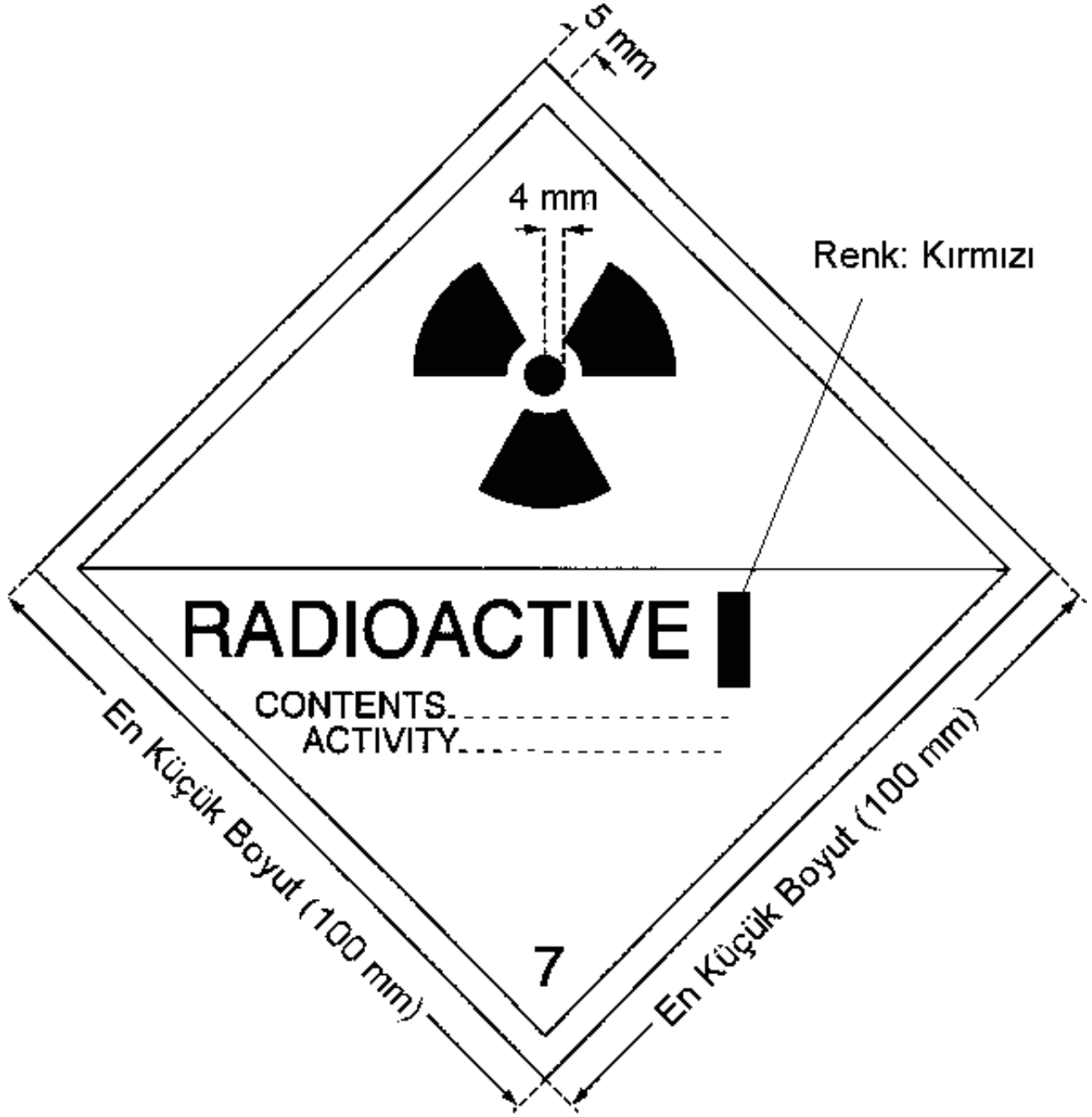

ŞEKİL 2 - Sınıf I-BEYAZ Etiketi

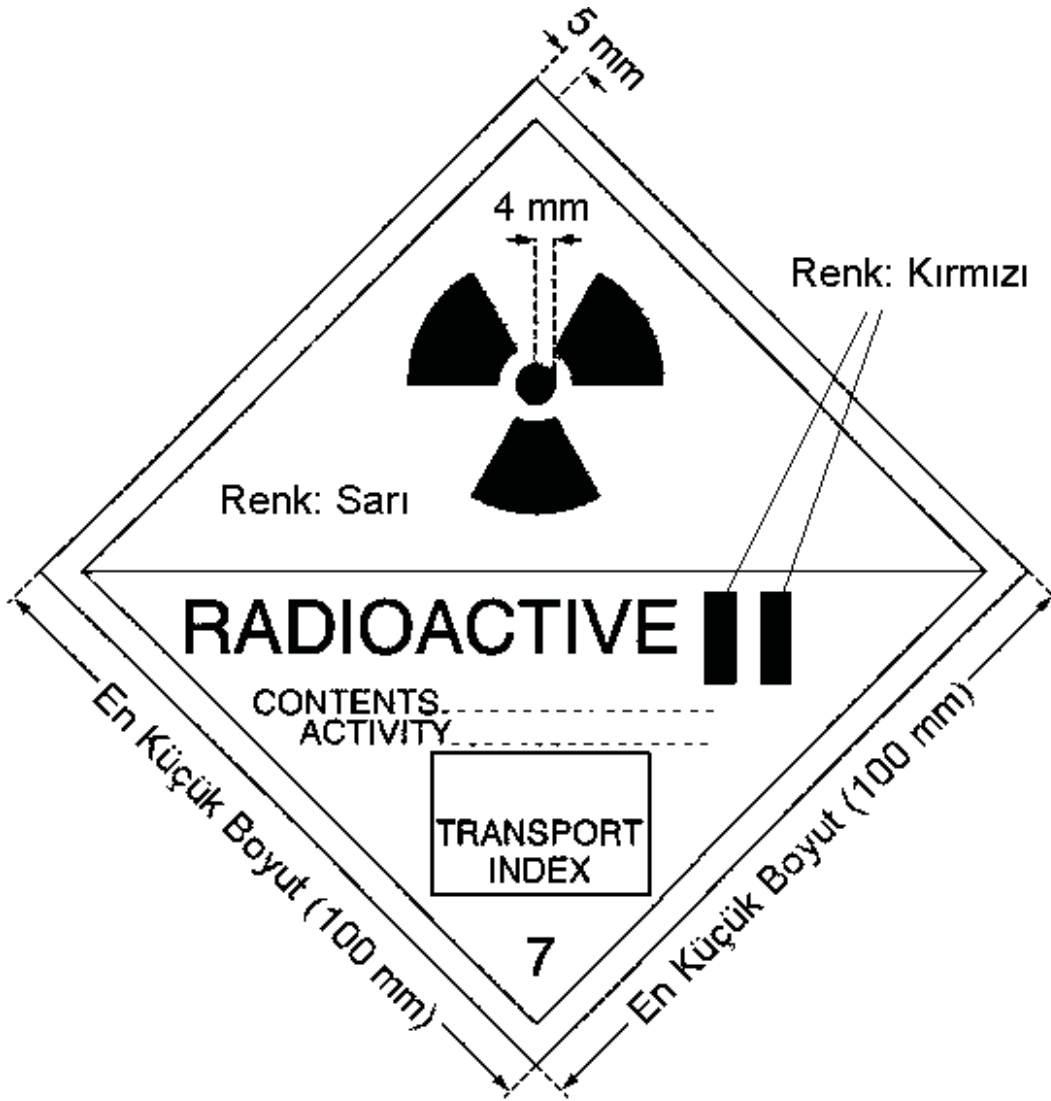

ŞEKİL 3 - Sınıf II-SARI Etiketi

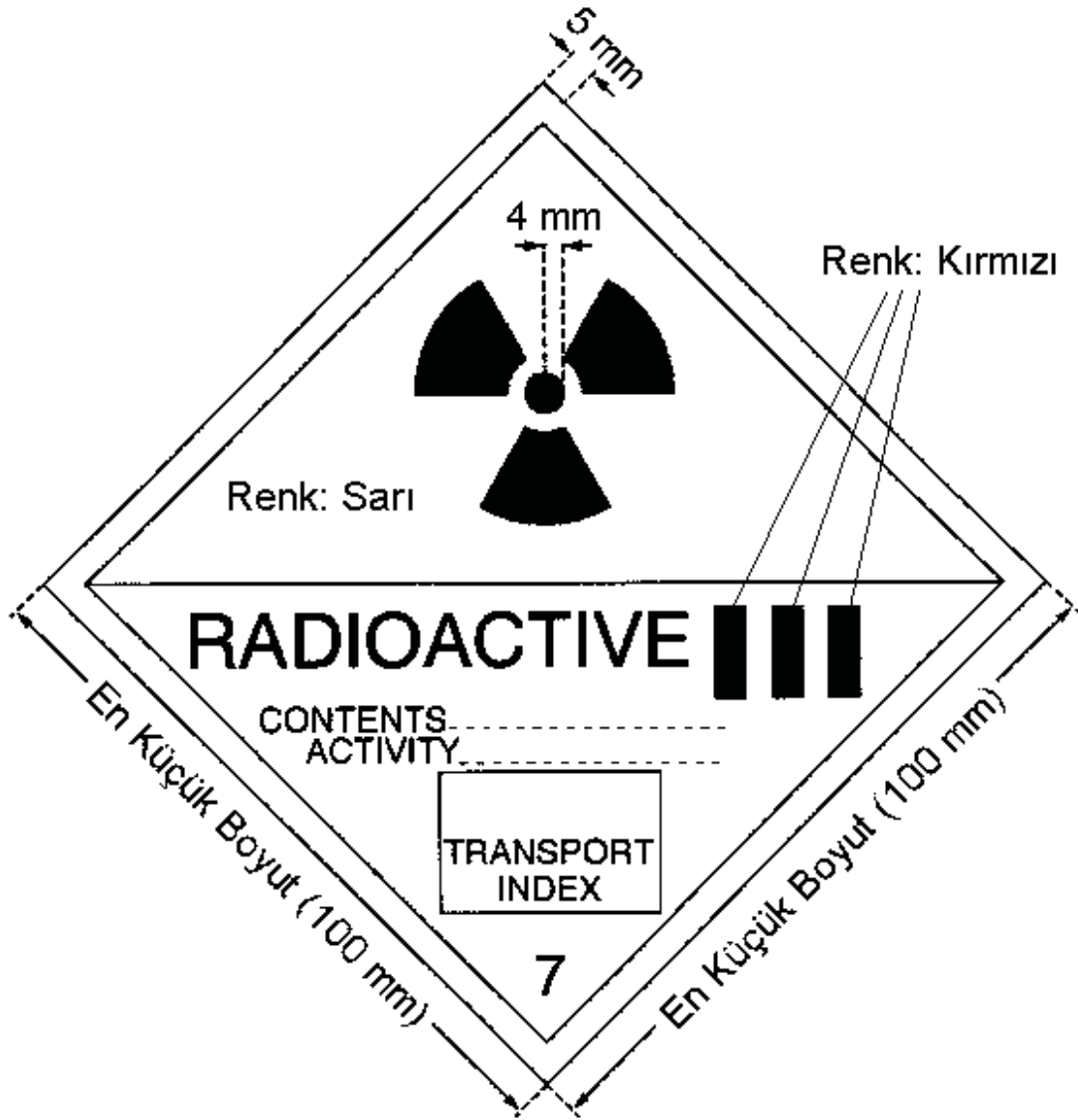

ŞEKİL 4 - Sınıf III-SARI Etiket

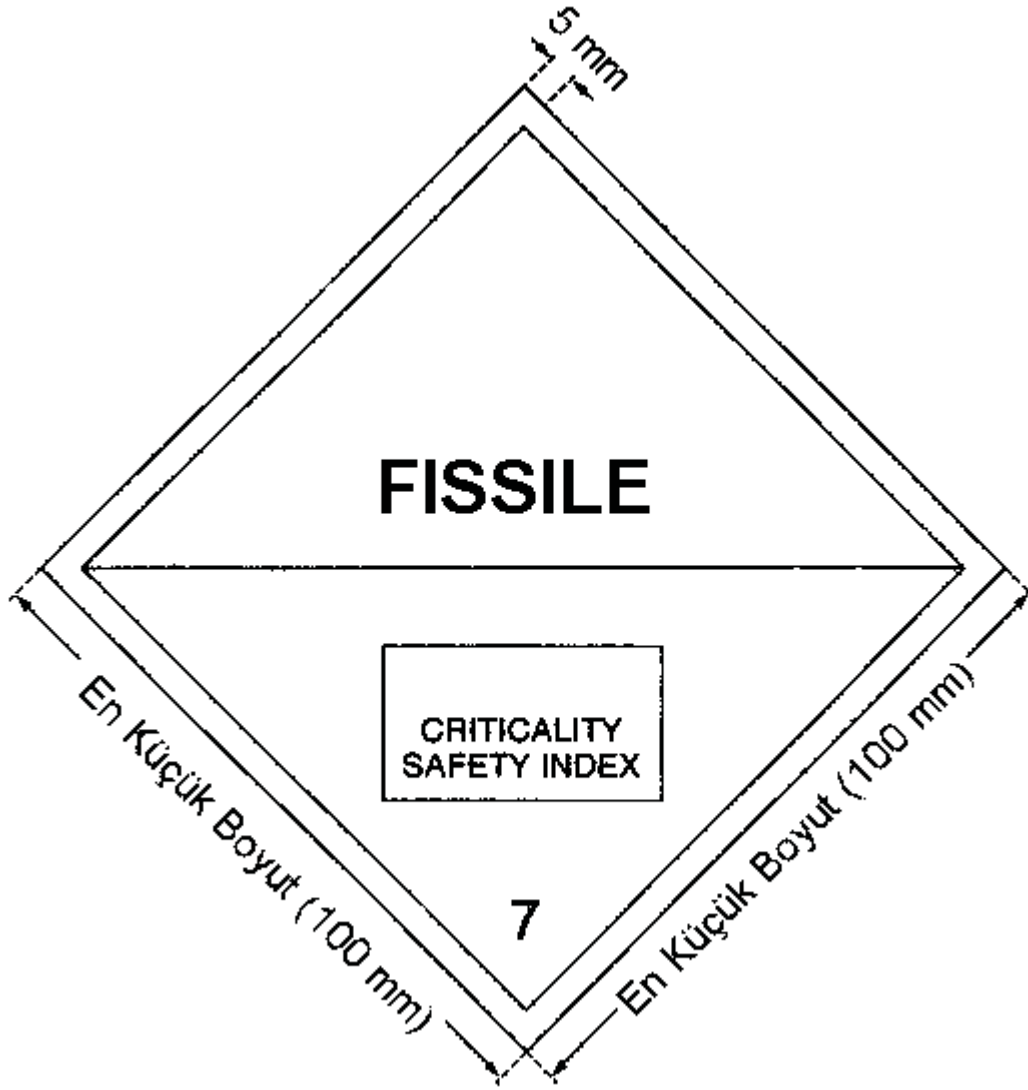

ŞEKİL 5 - Güvenlik İndisi Etiketi

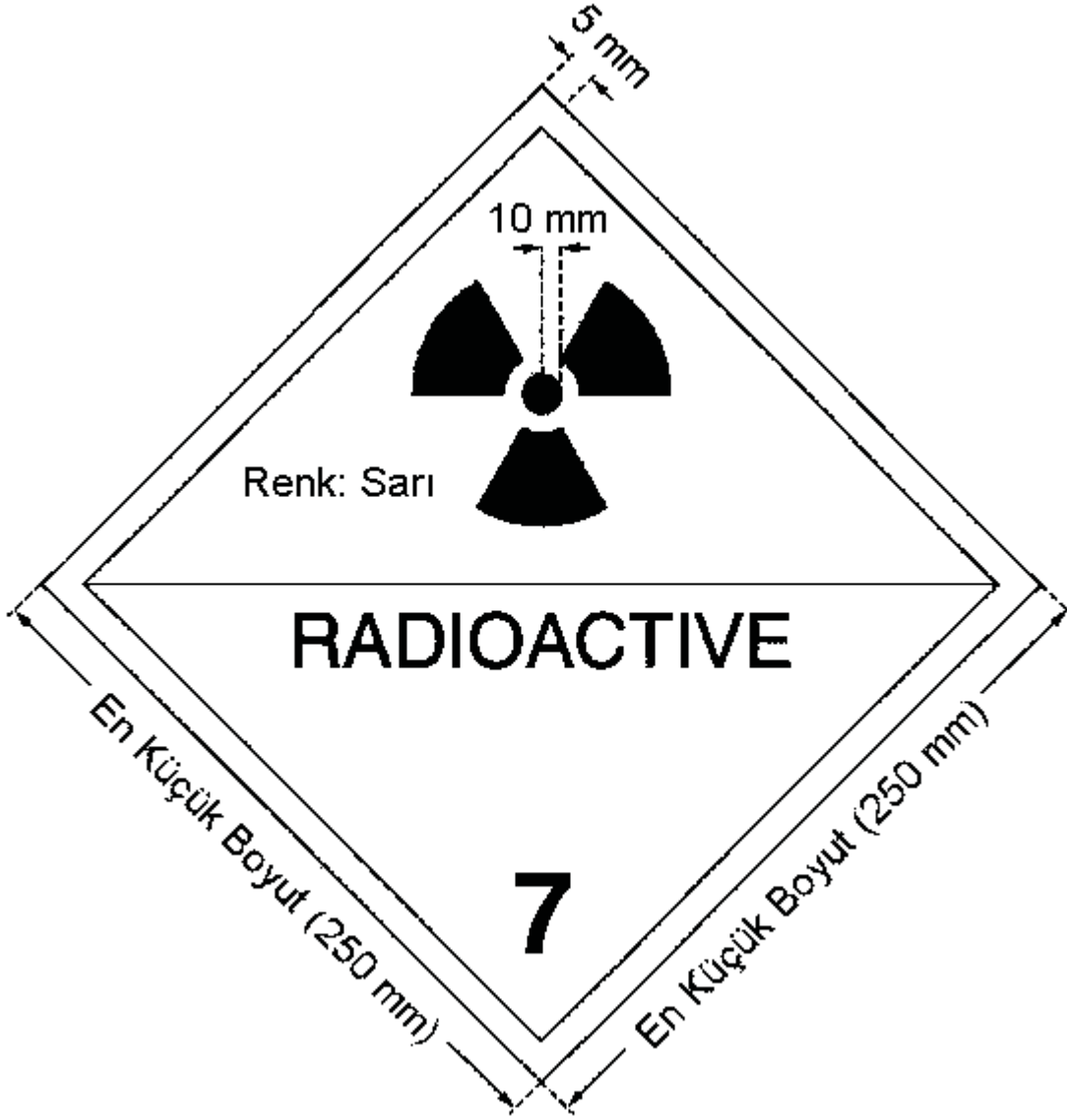

ŞEKİL 6 - Plaka

Ek-2

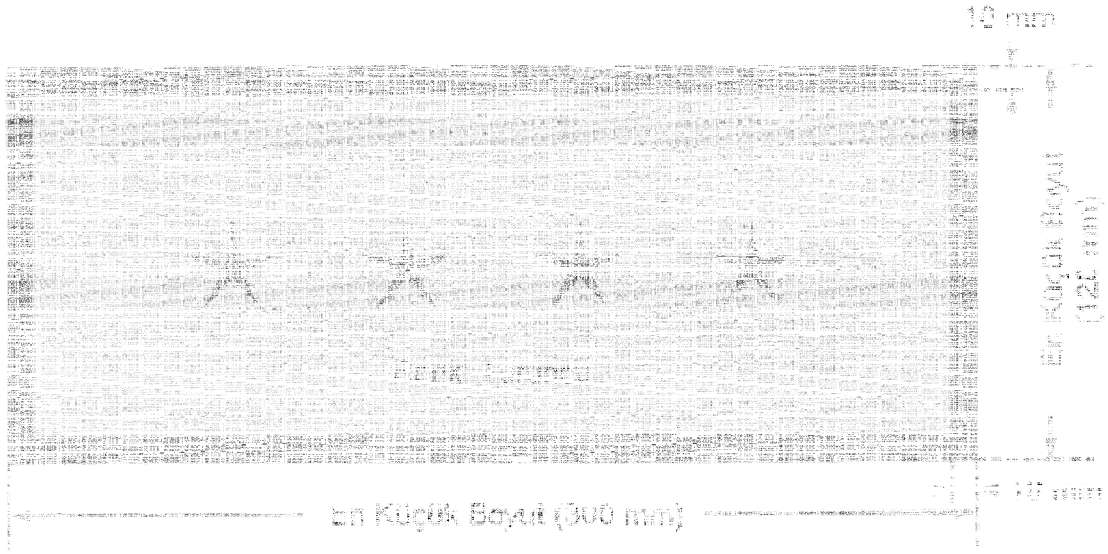

ŞEKİL 7 - Birleşmiş Milletler Radyoaktif Madde Plakası

Ek-3

**RADYOAKTİF MADDELER İÇİN BİRLEŞMİŞ MİLLETLER NUMARALARI VE
GÖNDERİ İSİMLERİ (PROPER SHIPPING NAME)**

(Uygulama) Schedule	UN No.	PROPER SHIPPING NAME ^a and description	(Diğer Riskler) Subsidiary risks
1	2910	RADIOACTIVE MATERIAL, EXCEPTED PACKAGE, -LIMITED QUANTITY OF MATERIAL,	
2	2911	RADIOACTIVE MATERIAL, EXCEPTED PACKAGE, -INSTRUMENTS or ARTICLES,	
3	2909	RADIOACTIVE MATERIAL, EXCEPTED PACKAGE, -ARTICLES MANUFACTURED FROM NATURAL URANIUM or DEPLETED URANIUM or NATURAL THORIUM,	
4	2908	RADIOACTIVE MATERIAL, EXCEPTED PACKAGE, -EMPTY PACKAGING	
5	2912	RADIOACTIVE MATERIAL, LOW SPECIFIC ACTIVITY (LSA-I), non fissile or fissile-excepted ^b	
6	3321	RADIOACTIVE MATERIAL, LOW SPECIFIC ACTIVITY (LSA-II), non fissile or fissile-excepted ^b	
7	3322	RADIOACTIVE MATERIAL, LOW SPECIFIC ACTIVITY (LSA-III), non fissile or fissile-excepted ^b	
8	2913	RADIOACTIVE MATERIAL, SURFACE CONTAMINATED	
9	2915	OBJECTS (SCO-I or SCO-II) non fissile or fissile-excepted ^b RADIOACTIVE MARETIAL, TYPE A PACKAGE, non-special form, non fissile or fissile-excepted ^b	
10	3332	RADIOACTIVE MARETIAL, TYPE A PACKAGE, SPECIAL FORM non fissile or fissile-excepted ^b	
11	2916	RADIOACTIVE MARETIAL, TYPE B(U) PACKAGE, non-special form, non fissile or fissile-excepted ^b	
12	2917	RADIOACTIVE MATERIAL, TYPE B(M) PACKAGE, non fissile or fissile-excepted ^b	
13	3323	RADIOACTIVE MATERIAL, TYPE C PACKAGE, non fissile or fissile-excepted ^b	
14	2919	RADIOACTIVE MATERIAL, TRANSPORTED UNDER SPECIAL ARRANGEMENT, non fissile or fissile-excepted ^b	
^c	2978	RADIOACTIVE MATERIAL, URANIUM HEXA- FLUORIDE, non fissile or fissile-excepted ^b	Corrosive (UN Class 8)
6+13	3324	RADIOACTIVE MATERIAL, LOW SPECIFIC ACTIVITY	

		(LSA-II) FISSILE	
7+13	3325	RADIOACTIVE MATERIAL, LOW SPECIFIC ACTIVITY (LSA-III) FISSILE	
8+13	3326	RADIOACTIVE MATERIAL, SURFACE CONTAMINATED OBJECTS (SCO-1 or SCO-II), FISSILE	
9+13	3327	RADIOACTIVE MATERIAL, TYPE A PACKAGE, FISSILE non-special form	
9+13	3333	RADIOACTIVE MATERIAL, TYPE A PACKAGE, SPECIAL FORM, FISSILE	
10+13	3328	RADIOACTIVE MATERIAL, TYPE B(U) PACKAGE, FISSILE	
11+13	3329	RADIOACTIVE MATERIAL, TYPE B(U) PACKAGE, FISSILE	
12+13	3330	RADIOACTIVE MATERIAL, TYPE C PACKAGE, FISSILE	
14+13	3331	RADIOACTIVE MATERIAL, TRANSPORTED UNDER SPECIAL ARRANGEMENT, FISSILE	
^c +13	2977	RADIOACTIVE MATERIAL, URANIUM HEXAFLUORIDE, FISSILE	Corrosive (UN Class 8)

^a Gönderi isimleri BÜYÜK HARFLER ile yazılır.
UN 2909 ve UN 2911 için, eğer alternatif gönderi isimleri var ise bunlar “veya” ile ayrılarak belirlenir ya da sadece ilgili olan isim belirtilir.

^b Madde 143’de belirtildiği şekilde.

^c UN 2977 ve UN 2978 özel durumları dolayısı ile listedeki uygulamalarla ilişkili değildir.